



# Aluminium Window & Door Systems

[aluk.co.uk](http://aluk.co.uk)

Experts in Aluminium

**ALUK**<sup>®</sup>





# Contents

- 5 By experts
- 6 Why choose aluminium?
- 8 A system for every application
- 10 Tried, tested and trusted
- 12 Functionality and flexibility
- 14 Window Systems
- 16 Optio 58BW Casement
- 18 Optio 58BW ST Heritage
- 20 Optio 58BW Tilt Before Turn
- 22 Optio 58BW Top Swing Reversible

- 24 Door Systems
- 26 Luminia 58BD Flush Entrance
- 28 Optio 58BD Entrance
- 30 GT55 TB Commercial Entrance
- 32 Infinium Sliding
- 34 Luminia SC156 Lift & Slide
- 36 Optio BSC94 Lift & Slide
- 38 Optio BSC94 In-line Sliding
- 40 Luminia F82 Bi-fold
- 42 Optio BSF70 Bi-fold
- 44 Luminia Veranda
- 46 Hardware





---

AT ALUK WE BELIEVE  
COLLABORATION IS KING.  
IT'S WHY WE'RE PROUD OF  
THE PARTNERSHIPS WE'VE  
BUILT WITH FABRICATORS,  
INSTALLERS AND  
ARCHITECTS THROUGHOUT  
THE UK AND BEYOND

---

## By experts, for experts

It's fair to say we live and breathe aluminium at AluK. From its melting point of 660.32°C, its vital role in the aerospace industry, to its remarkable low density, there's little we don't know about atomic number 13. More importantly, we're experts at using this versatile metal to create high performance and sustainable window and door systems that surpass the needs of fabricators and installers across the UK.

From the production line to our design and sales offices, every member of the AluK team is a leader in their field. It's this collective expertise and our traditional family values that has enabled us to design, engineer and manufacture industry-leading façade systems for over 20 years.

Boasting slimmer sightlines and greater feature options, all our products are manufactured to the highest UK standards. So whether commercial or residential, modern or traditional, you can be confident our experts will ensure every AluK product delivers peerless performance and signature style.

*Russell*  
**Russell Yates**  
AluK Managing Director



# Why choose AluK aluminium systems?

For over 30 years, we've been at the forefront of aluminium window and door design.

## But why aluminium?

It's lightweight, strong and almost 100% recyclable.

It doesn't warp or rust and is near maintenance-free.

Plus it's exceptionally versatile and easy to install.

And that's really just for starters.

## Design

Without compromising on strength, our aluminium window and door systems are designed to offer your customers the narrowest of sightlines, allowing bigger glazing and providing greater light into their home.

Our integrated systems are designed for maximising profiles and parts, as well as to ensure fast fabrication and a wide range of installation options.

## Colour

Access a large spectrum of contemporary and classic colour choices and finishes.

We also offer a range of standard single and dual colour products from stock with our Colour+ offer

For full Colour+ details email [info@aluk.co.uk](mailto:info@aluk.co.uk)

## Security

We understand the importance of security to your customers. That's why all our window and door systems are independently tested to ensure they not only meet current security regulations for new builds, but that they're inherently burglar resistant too.

Most of our systems are also certified by PAS 24, Secured by Design and Q-marked accredited.

## Thermal efficiency

Our window and door systems offer award-winning U-value performance for both double and triple glazing.

In fact, we were the first company to ever gain an A-rated aluminium double glazed window system in the market.

## Window Energy Ratings (WERs)

Our aluminium window systems are rated for their energy efficiency using the familiar A-G scale. This means homeowners and architects can instantly see which windows to choose.

WERs also affect fabricators, because in order to supply WER

## Performance

Each system includes water and acoustic barriers, and utilises the latest manufacturing technologies and techniques to provide long-term peace of mind.

They also have integrated drainage paths that allow water to pass through the system.

This, combined with the high quality air seals and barriers, ensures they can tackle the everchanging British climate with ease.

products a fabricator must join an official and recognised scheme.

This is to ensure that manufacturers can prove they have audited processes in place and that the ratings displayed are accurate.

As you'd expect, we have our own group scheme at AluK.

This provides members fast track access to all our WER data, saving them valuable time and effort.

For a more detailed look at the ratings, download our **WER guide** at [aluk.co.uk](http://aluk.co.uk)

## Service excellence

Expert service is key at AluK, so our trained architectural technicians and engineers are always on hand to offer guidance and support from design through to installation.

We also have highly experienced Project Consultants able to help with design, system selection, construction details and project specifications for your specific sector.

## AluK Academy

Training is another key service we provide. From CPDs and toolbox talks to hands-on guidance at our Academy Centre, we provide a wide range of training options to all our customers.

To find out more simply email [training.uk@aluk.com](mailto:training.uk@aluk.com)



# An AluK system for every application

If there's one thing homeowners, architects, installers and fabricators all have in common, it's the desire for choice. That's why we've created our wide range of aluminium façade systems, which meets the needs of different applications, performance and aesthetic demands.

To make life easy for homeowners, we've created three product ranges based on their individual requirements.

- ▶ For those looking for the thinnest sightlines and finest finish, there's our premium Infinium sliding door.
- ▶ If outstanding quality and standout at a competitive price is desired, the Luminia range is the obvious choice.
- ▶ While stylish design and everyday practicality is provided by the Optio range.

From a fabricator and installer perspective, we offer systems that cover everything from heavy duty and light commercial new builds, to large-scale refurbishment projects and residential new builds.

Whatever choice you make, you can be confident that our systems offer the superior performance and quality of aluminium through and through.

Residential



Multi-Residential



Light commercial



Commercial



# Tried, tested and trusted

From trusted favourites to the latest innovations, our comprehensive range of aluminium window and door systems has been designed and developed with fabricators, installers and homeowners in mind at every stage.

Furthermore, every system delivers the aesthetic appeal and exceptional build quality demanded by the industry.

It also goes without saying they've all been tested and certified to the latest standards and accreditations.

These include PAS 24, BS4873, Secured By Design and Qualicoat for starters. Not to mention ISO 9001. They also hold Q-Mark Certifications for general

performance windows and enhanced security windows and doors. Should we go on?

Whichever system you choose, we'll work closely with you to ensure you have all the information you require for successful fabrication and installation.

All the latest structural, thermal and wind calculations are available, as is a comprehensive suite of CAD, NBS Specifications performance and environmental data.

## ALWAYS UP TO THE TEST







# AluK window systems

**For over two decades we've been designing unique aluminium window systems that exceed the performance standards expected in modern building design.**

Manufactured to the highest standards, our systems are available in depths of 58mm, 70mm and 77mm, with a wide choice of colours and finishes customers desire, with the performance, quality and flexibility the trade demands.

An extensive range of complementary fittings is also available to ensure every design, whether commercial or residential, is exceptional.

We understand reputations are everything, so it goes without saying that all our aluminium window systems are rigorously tested and meet the most stringent security standards.

They also meet the Secured by Design standard issued by the UK Association of Chief Police Officers, and are BRE A-rated on the green guide.



# Functionality and flexibility

We offer a wide range of windows frame options that cater for various applications such as interface depths or bay angles.

We also understand that the ability to combine frame options is a major benefit to both the cost and appearance.

Our frame options include deep head profiles for trickle vents, odd leg frames for accommodating hardware timber and heritage for overcoming stone mullion and cill details.

Equal leg frame options are available from 25mm, 35mm and 55mm options.

Frame extenders are also available for our 70mm systems and for improved U-values.

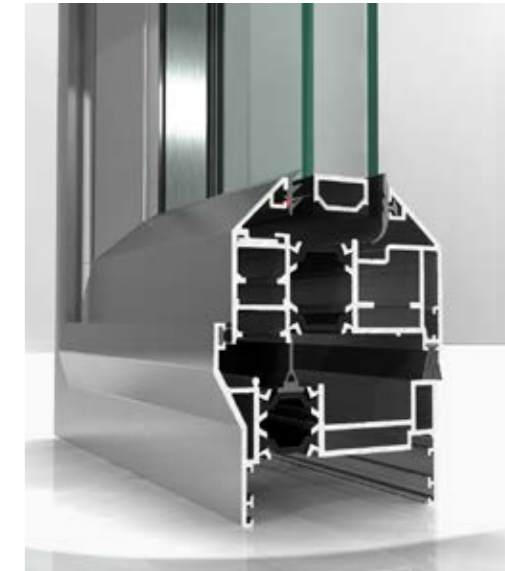

## › Glazing options

Every project is different, which is why our systems allow for both internal and external glazing options.

We also offer glazing add-ons to suit heritage style applications.

## › Aesthetics

We offer a wide range of internal and external aesthetic styles. Chamfered, Ovolo, Square or Putty line options can really make any project look modern or traditional.

Our double beaded options allow for internal glazing without the use of dummy vents.

## › Openings

AluK windows are available in a full range of opening options; from open in to open out, side hung, top hung, bottom hung and tilt before turn, to French casement, fixed light and multi-light.

## DESIGN FEATURES

- › From odd leg and equal leg to deep head and frame reversers
- › Internal and external glazing options
- › PAS 24 certified
- › Integrated systems for maximising profiles and parts
- › Three chamber profile for maximising strength while crimping - achieves perfect corner assembly every time



Optio

# 58BW Casement

Built to the highest UK standards, this effective and high performance solution offers clean lines and advanced functionality.

Available in either 58mm or 70mm frame depth, casement windows are the perfect choice for both residential and light commercial projects, whether new build or renovation. Windows can also be made to project in or out.



## DESIGN FEATURES

- Certified under the Secured By Design scheme
- Tested to PAS 24
- Green guide rated A
- Integrated deep head profiles for ease of trickle ventilation
- Unique polyamide thermal break design to improve thermal performance

## OPTIONS

- 58mm or 70mm frame depth to accommodate varying types of applications
- Project in or project out options
- Internally or externally glazed to accommodate low and high rise projects
- Glazing 24mm – 40mm
- Available in a range of single or dual colour and anodised finishes
- Available in the following aesthetics: Bay, Chamfered, Square and Ovolo.
- Available in the following configurations: top hung, side hung, bottom hung, fixed light, multi-light and French casement
- Available for Lifetime Homes (LFT)
- Double beaded option allowing for internal glazing without the use of dummy vents
- Dedicated fixing straps for ease of installation
- Designed with a Euro groove to accommodate standard locking hardware



➤ Ovolo



➤ Chamfered



➤ Square

## SPECIFICATIONS

Performance and accreditation	Outward opening
U-value (double glazing)	1.4 W/m²K
U-value (triple glazing)	1.2 W/m²K
Window energy rating (WER)	B - C
Green guide rating	A rated
Acoustic performance (dB)	Rw (C;Ctr) 42 (-1;-5) dB
Air tightness (Pa)	Class 4 (600 Pa)
Water tightness (Pa)	Class 9A (600 Pa)
Wind load (Pa)	Class E2400 (2400 Pa)
Security	PAS 24
3rd party certification	Q-mark
Secured by design	Yes

## Configurations

Opening	Open out
Top hung	✓
Side hung	✓
Bottom hung	✓
Fixed light	✓
Multi-light	✓
French casement	✓

## Size limits

Top hung (max weight)	180 Kg
Side hung (max weight)	55 Kg
Bottom hung (max weight)	60 Kg (3 hinges)
Fixed light (max weight)	250 Kg

## System features

Frame depth	58mm and 70mm
Dual colour option	✓
Multi-point locking	✓
Glazing options	Internal and external bead
Glazing thickness	24mm - 40mm
Sightline (Frame to Vent)	75mm
Sightline (Vent to Mullion)	89mm
Sightline (Fixed Light)	43mm

## Aesthetics

Bay	✓
Chamfered	✓
Square	✓
Ovolo	✓

U-value (Double Glazing) - Windows are calculated using EN ISO 10077 - Part 2, 1230mm x 1480mm Side hung next to fixed light with Ug: 1.0 W/m²K using AW603 outerframe and AW610 vent  
 U-value (Triple Glazing) - Windows are calculated using EN ISO 10077 - Part 2, 1230mm x 1480mm Side hung next to fixed light with Ug: 0.7 W/m²K using AW603 outerframe and AW610 vent  
 Green Guide Rating - Calculated using the Green Guide 2008 ratings for domestic windows, Powder Coated Aluminium window (Profile <0.88kg/m) double glazed  
 Acoustic Performance (dB) - Tested using AW605 outerframe and AW620 vent, 10/16/8.4mm Acoustic Laminated Glass  
 Top Hung (max weight) - Based upon Sterling SPT26 top hung friction stay  
 Side Hung (max weight) - Based upon Securistyle Sterling SPSH16 side hung friction stay  
 Bottom Hung (max weight) - Based upon 3 x RW20M hinges

## CAD CROSS SECTIONS

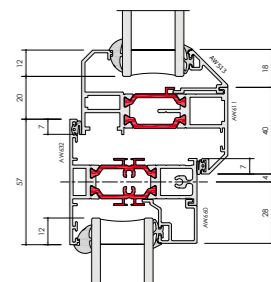
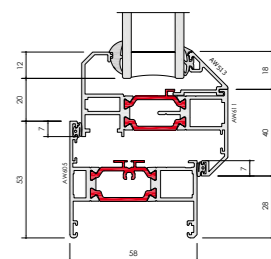
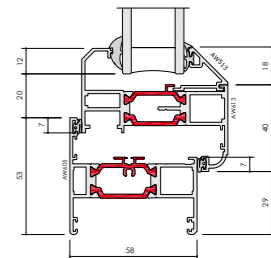
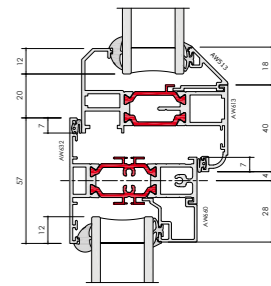



Optio

# 58BW ST Heritage

The look of steel, the benefits of aluminium.  
A win-win for designers and homeowners alike.

Featuring industry-leading build quality, our 58BW ST aluminium windows are an ideal replacement for existing steel windows.

In addition to impressive high thermal and acoustic performance, the design also replicates the minimal sightlines associated with steel windows, whilst providing superior performance and security.



### DESIGN FEATURES

- › Certified under the Secured By Design scheme
- › Tested to PAS 24
- › Green guide rated A
- › Integrated deep head profiles for ease of trickle ventilation
- › Unique polyamide thermal break design to improve thermal performance
- › Slim sightlines to match existing steel window
- › Internally beaded for ease of glazing on highrise projects

### OPTIONS

- › 58mm or 70mm frame depth to accommodate varying types of applications
- › Internally or externally glazed
- › Glazing 24mm – 32mm
- › Available for Lifetime Homes (LFT)
- › Available in a range of single or dual colour and anodised finishes
- › Available in the following aesthetics: Stepped Edge, Square and Putty Line
- › Available in the following configurations: top hung, side hung, bottom hung, fixed light, multi-light and French casement
- › Double headed option allows for internal glazing without the use of dummy vents
- › Accommodates standard hardware



› Square



› Putty Line



› Stepped Edge

### SPECIFICATIONS

Performance and accreditation	Outward opening
U-value (double glazing)	1.4 W/m²K
U-value (triple glazing)	1.2 W/m²K
Window energy rating (WER)	A - B
Green guide rating	A rated
Acoustic performance (dB)	Rw (C;Ctr) 43 (-2;-5) dB
Air tightness (Pa)	Class 4 (600 Pa)
Water tightness (Pa)	Class 9A (600 Pa)
Wind load (Pa)	Class E2400 (2400 Pa)
Security	PAS 24
3rd party certification	Q-mark
Secured by design	Yes

Configurations	
Opening	Open out
Top hung	✓
Side hung	✓
Bottom hung	✓
Fixed light	✓
Multi-light	✓
French casement	✓

Size limits	
Top hung (max weight)	35 Kg
Side hung (max weight)	24 Kg
Bottom hung (max weight)	60 Kg (3 hinges)
Fixed light (max weight)	250 Kg

System features	
Frame depth	58mm and 70mm
Dual colour option	✓
Multi-point locking	✓
Glazing options	Internal and external
Glazing thickness	24mm - 32mm
Sightline (Frame to Vent)	66mm
Sightline (Vent to Mullion)	81mm
Sightline (Fixed Light)	43mm

Aesthetics	
Putty Line	✓
Stepped Edge	✓
Square	✓

U-value (Double Glazing) - Windows are calculated using EN ISO 10077 - Part 2, 1230mm x 1480mm Side hung next to fixed light with Ug: 1.0 W/m²K using AW603 outerframe and AW614 vent  
 U-value (Triple Glazing) - Windows are calculated using EN ISO 10077 - Part 2, 1230mm x 1480mm Side hung next to fixed light with Ug: 0.7 W/m²K using AW603 outerframe and AW685 vent  
 Green Guide Rating - Calculated using the Green Guide 2008 ratings for domestic windows, Powder Coated Aluminium window (Profile <0.88kg/m) double glazed  
 Acoustic Performance (dB) - Tested using AW604 outerframe and AW685 vent, 8/16/8.8mm Acoustic Laminated Glass  
 Top Hung (max weight) - Based upon Nico 24" Standard top hung friction stay  
 Side Hung (max weight) - Based upon Nico 16" Standard side hung friction stay  
 Bottom Hung (max weight) - Based upon 3 x RW20M hinges

### CAD CROSS SECTIONS

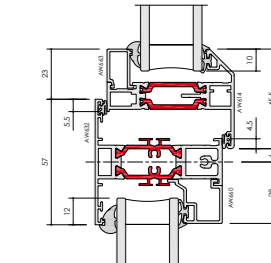
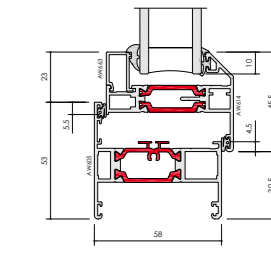
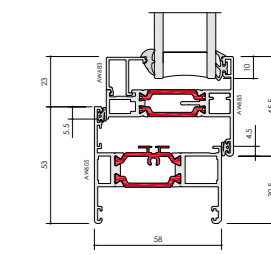
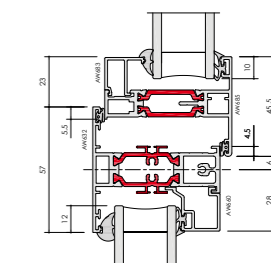



Optio

# 58BW Tilt Before Turn

Offering exceptional child safety and seamless operation, our tilt before turn windows are an ever-popular choice for both multi-residential and light commercial applications.

Made from high performance aluminium these sustainable systems are inherently strong and lightweight. They're also an ideal solution for high-rise buildings where internal glazing and ease of cleaning are essential.



### DESIGN FEATURES

- Certified under the Secured By Design scheme
- Tested to PAS 24
- Green guide rated A
- Integrated deep head profiles for ease of trickle ventilation
- Unique polyamide thermal break design to improve thermal performance
- Sightlines match the casement window

### OPTIONS

- Glazing 24mm – 40mm
- Available in a range of single or dual colour and anodised finishes
- Available in the following aesthetics: Bay, Contemporary and Square
- Available in the following configurations: tilt-before-turn, side hung, fixed light and multi-light
- Available for Lifetime Homes (LFT)

### SPECIFICATIONS

Performance and accreditation	Outward opening
U-value (double glazing)	1.5 W/m²K
U-value (triple glazing)	1.3 W/m²K
Window energy rating (WER)	B - C
Green guide rating	A rated
Acoustic performance (dB)	Rw (C;Ctr) 44 (-1;-4) dB
Air tightness (Pa)	Class 4 (600 Pa)
Water tightness (Pa)	Class 8A (450 Pa)
Wind load (Pa)	Class E2400 (2400 Pa)
Security	PAS 24
3rd party certification	Q-mark
Secured by design	Yes

### Configurations

Opening	Open out
Tilt before turn	✓
Side hung	✓
Fixed light	✓
Multi-light	✓

### Size limits

Tilt before turn (max weight)	100 Kg
Side hung (max weight)	100 Kg
Fixed light (max weight)	250 Kg

### System features

Frame depth	58mm and 70mm
Dual colour option	✓
Multi-point locking	✓
Glazing options	Internal and external
Glazing thickness	24mm - 40mm
Sightline (Frame to Vent)	86mm
Sightline (Vent to Mullion)	100mm
Sightline (Fixed Light)	43mm

### Aesthetics

Bay	✓
Contemporary	✓
Square	✓

U-value (Double Glazing) - Windows are calculated using EN ISO 10077 - Part 2, 1230mm x 1480mm Side hung next to fixed light with Ug: 1.0 W/m²K using AW603 outerframe and AW621 vent  
 U-value (Triple Glazing) - Windows are calculated using EN ISO 10077 - Part 2, 1230mm x 1480mm Side hung next to fixed light with Ug: 0.7 W/m²K using AW603 outerframe and AW621 vent  
 Green Guide Rating - Calculated using the Green Guide 2008 ratings for domestic windows, Powder Coated Aluminium window (Profile <1.08kg/m) double glazed  
 Acoustic Performance (dB) - Tested using AW604 outerframe and AW621 vent, 12/16/10.8mm Acoustic Laminated Glass  
 Tilt Before Turn (max weight) - Based upon Winkhaus Auto Pilot Gearing  
 Side Hung (max weight) - Based upon Winkhaus Auto Pilot Gearing

### CAD CROSS SECTIONS

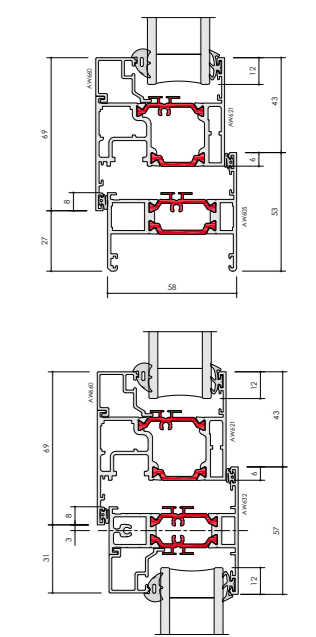



Optio

# 58BW Top Swing Reversible

Easy to clean and effortless to operate, our ever-popular top swing reversible windows increase thermal performance, improve safety and exceed modern building design performance standards.

Ideal for use in high-rise structures, the windows open an impressive 180°, allowing completely pain-free pane cleaning. The system does not encroach inside the building, as the mechanism allows the opening sash to completely rotate on itself whilst remaining outside the building structure.



## DESIGN FEATURES

- › Certified under the Secured By Design scheme
- › Tested to PAS 24
- › Green guide rated A
- › Integrated deep head profiles for ease of trickle ventilation
- › Unique polyamide thermal break design to improve thermal performance
- › A clean, flat appearance to give a true contemporary aesthetic
- › Design allows the windows to be pivoted without intruding the internal building line

## OPTIONS

- › Glazing 24mm – 28mm
- › Available in a range of single or dual colour and anodised finishes
- › Available in the following aesthetics: Bay, Contemporary and Chamfered
- › Available in the following configurations: top swing, side swing, fixed light and multi-light
- › Dedicated fixing strips for ease of installation
- › Full range of customisable hardware available

## SPECIFICATIONS

Performance and accreditation	Outward opening
U-value (double glazing)	1.7 W/m <sup>2</sup> K
Green guide rating	A rated
Air tightness (Pa)	Class 4 (600 Pa)
Water tightness (Pa)	Class 6A (250 Pa)
Wind load (Pa)	Class A5 (2000 Pa)
Security	PAS 24
3rd party certification	Q-mark
Secured by design	Yes
Configurations	
Opening	Open out
Top swing	✓
Side swing	✓
Fixed light	✓
Multi-light	✓
Size limits	
Top swing (max weight)	60 Kg
Side swing (max weight)	45 Kg
Fixed light (max weight)	250 Kg
System features	
Frame depth	70mm
Dual colour option	✓
Multi-point locking	✓
Glazing options	Internal
Glazing thickness	24mm - 28mm
Sightline (Frame to Vent)	103mm
Sightline (Vent to Mullion)	161mm
Aesthetics	
Bay	✓
Contemporary	✓
Square	✓

U-value (Double Glazing) - Windows are calculated using EN ISO 10077 - Part 2, 1230mm x 1480mm Single Opening light with Ug: 1.0 W/m<sup>2</sup>K using AW561 outerframe and AW562 vent  
 Green Guide Rating - Calculated using the Green Guide 2008 ratings for commercial windows, Powder Coated Aluminium window (Profile <1.25kg/m) double glazed  
 Top Swing (max weight) - Based upon PN Uni Topswing Gearing  
 Side Swing (max weight) - Based upon PN Uni Sideswing Gearing

## CAD CROSS SECTIONS

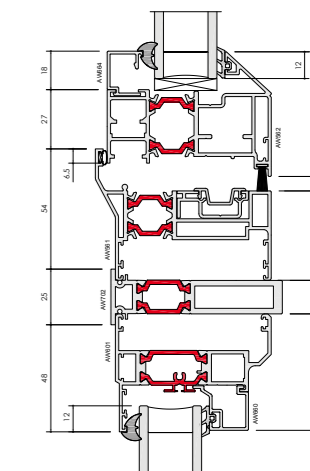
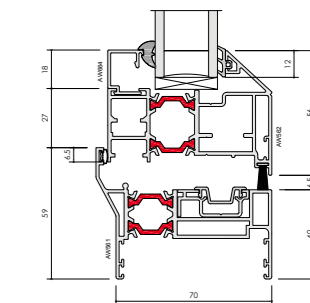





# AluK door systems

Engineered to integrate seamlessly with our window system range, our aluminium door systems remain our most popular products and provide unrivalled safety, security and installation simplicity.

Each door system has its own distinct look and feel, offering varying levels of performance, profile depth and glazing area.

However, while our designs may differ you'll find our materials and manufacturing processes are as reliable as ever. You have our guarantee. A 10-year one in fact.

In addition to meeting the needs of every application type, our doors also support the current industry trend for refurbishment over replacement.

This allows fabricators and installers to provide the additional light and space their customers want, in the most fitting way possible.



Luminia

# 58BD Flush Entrance

The NEW contemporary modern door system. Available in variety of formats, with slim sightlines and flush aesthetics.



## DESIGN FEATURES AND OPTIONS

- Accepts 24mm – 40mm double or triple glazing
- Max vent weight 90kg
- Max Frame Height 2160mm
- Multi-point locking mechanism
- Available in single and dual colour

## SPECIFICATIONS

Performance and accreditation	Single open in	Single open out	Double open in	Double open out
Air permeability (Pa)	Class 4 (600 Pa)	Class 4 (600 Pa)	Class 2 (300 Pa)	Class 2 (300 Pa)
Water tightness (Pa)	Class 3A (100 Pa)	Class 7A (300 Pa)	Class 7A (300 Pa)	Class 9A (600 Pa)
Wind resistance (Pa)	Class A3 (1200 Pa)	Class AE2400 (2400 Pa)	Class A2400 (2400 Pa)	Class A2400 (2400 Pa)
Building regulations part L compliant	✓	✓	✓	✓
Building regulations part M compliant	✓	✓	✓	✓
Security	PAS 24	PAS 24	PAS 24	PAS 24
U-value (double glazing) (Ug: 1.0 W/m2k) <sup>1</sup>	1.7 W/m2K	1.7 W/m2K	1.7 W/m2K	1.7 W/m2K
U-value (triple glazing) (Ug: 0.7 W/m2k) <sup>2</sup>	1.4 W/m2K	1.4 W/m2K	1.4 W/m2K	1.4 W/m2K
3rd party certification	Q-mark	Q-mark	Q-mark	Q-mark
Durability EN 1191 category (cycles)	50,000	50,000	50,000	50,000
<b>System depth</b>				
Units (mm)	58 / 70 mm	58 / 70 mm	58 / 70 mm	58 / 70 mm
<b>Design features</b>				
Thermally broken	✓	✓	✓	✓
Low threshold	✓	✓	✓	✓
Sightlines	119 mm	119 mm	208 mm	208 mm
Feature design - rounded contours lines	✓	✓	✓	✓
Panel door	✓	✓	✓	✓
<b>Hardware</b>				
Multi point locking	✓	✓	✓	✓
Barrel hinges	✓	✓	✓	✓
<b>Finishes</b>				
Single colour	✓	✓	✓	✓
Dual colour	✓	✓	✓	✓
Textured	✓	✓	✓	✓
Anodised	✓	✓	✓	✓
<b>Maximum sizes &amp; weights</b>				
Maximum door leaf size (mm)	1020 x 2160	1020 x 2160	1020 x 2160	1020 x 2160
Maximum door leaf weight	90 Kg	90 Kg	90 Kg	90 Kg
Maximum glazing thickness	24 - 40 mm	24 - 40 mm	24 - 40 mm	24 - 40 mm
<b>Applications</b>				
New build	✓	✓	✓	✓
Refurbishment	✓	✓	✓	✓

<sup>1</sup> U-value in accordance EN 10077-2, single door size 1000mm x 2180mm.  
<sup>2</sup> U-value in accordance EN 10077-2, double door size 2000mm x 2180mm.  
 U-values based on CEN size door (1000mm x 2180mm) using 1.0 W/m2K double glazing with warm edge Swisspacer V bar.  
 All weather test data taken from BS EN 6375-1 (Part of PAS 23) based upon the highest performing door configuration.  
 Sound insulation values are Rw reduction values and are based on tests using acoustic glazing.  
 Please visit aluk.co.uk to download all BIM components and CAD files.

## CAD CROSS SECTIONS

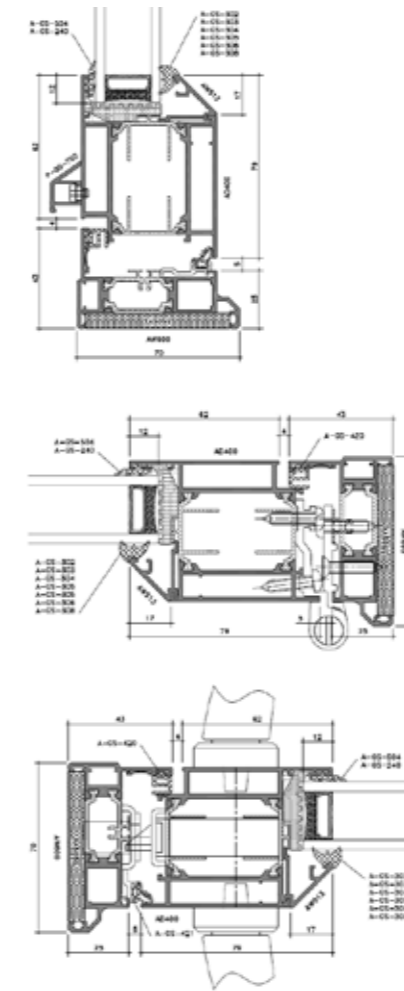

## 58BD CONFIGURATIONS

### Key

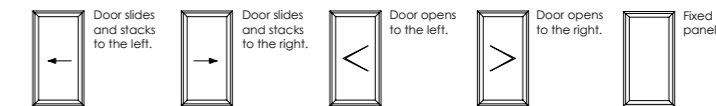

### Single



### Double

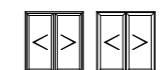



Optio

# 58BD Entrance

Available in a wide range of styles and formats, our stylish aluminium entrance door system is suitable for both light and medium-duty use.

Designed with security and flexibility front of mind, every door in the range is available in single and double configurations making them ideal for almost any application.



#### DESIGN FEATURES

- Certified under the Secured By Design scheme
- Tested to PAS 24
- Multi-point locking mechanism
- Designed to incorporate standard and security hardware using the same prep detail
- Cloaking feature conceals lock and prevents any access to locking points

#### OPTIONS

- Glazing 24mm – 40mm
- 58mm or 70mm frame depth to accommodate varying types of applications
- Low threshold option for Part M – Building regulation
- Available in a range of single or dual colour and anodised finishes
- Available for new build or refurbishment projects
- Available in single or double door configuration

#### SPECIFICATIONS

Performance & accreditations	Single open in	Single open out
Air permeability	Class 4 (600 Pa)	Class 4 (600 Pa)
Water penetration	Class 3A (100 Pa)	Class 7A (300 Pa)
Wind resistance	Class A3 (1200 Pa)	Class AE2400 (2400 Pa)
Building regulations part L compliant	✓	✓
Building regulations part M compliant	✓	✓
Building regulations part Q compliant	✓	✓
*U-value (double glazing)	1.7 W/m²K	1.7 W/m²K
†U-value (triple glazing)	1.4 W/m²K	1.4 W/m²K
Fire (EN1631-3)	npd	npd
Smoke (EN1631-3)	npd	npd
Security	PAS 24	PAS 24
3rd party certification	Q-mark	Q-mark
Secured by design	Yes	Yes
Durability EN1191 category	50,000 Cycles	50,000 Cycles
<b>System depth</b>		
Units (mm)	58mm and 70mm	58mm and 70mm
<b>Design features</b>		
Thermally broken	✓	✓
Low threshold	✓	✓
Panel door	✓	✓
Feature design - rounded contours	✓	✓
Sightline (Head)	120mm	120mm
Sightline (Cill)	111mm	111mm
Sightline (Jamb)	120mm	120mm
Sightline (Meeting Stile)	208mm	208mm
<b>Hardware</b>		
Multi-point locking	✓	✓
Barrel hinges	✓	✓
<b>Finishes</b>		
Single colour	✓	✓
Dual colour	✓	✓
Textured	✓	✓
<b>Maximum sizes and weights</b>		
Maximum door leaf size	1020mm x 2160mm	1020mm x 2160mm
Maximum door leaf weight	90 Kg	90 Kg
Maximum glazing thickness	24mm - 40mm	24mm - 40mm

Double open in	Double open out
Class 2 (300 Pa)	Class 2 (300 Pa)
Class 7A (300 Pa)	Class 9A (600 Pa)
Class A2400 (2400 Pa)	Class A2400 (2400 Pa)
✓	✓
✓	✓
✓	✓
1.7 W/m²K	1.7 W/m²K
1.5 W/m²K	1.5 W/m²K
npd	npd
npd	npd
PAS 24	PAS 24
Q-mark	Q-mark
Yes	Yes
50,000 Cycles	50,000 Cycles
58mm and 70mm	58mm and 70mm
✓	✓
✓	✓
✓	✓
✓	✓
120mm	120mm
111mm	111mm
120mm	120mm
208mm	208mm
✓	✓
✓	✓
✓	✓
1020mm x 2160mm	1020mm x 2160mm
90 Kg	90 Kg
24mm - 40mm	24mm - 40mm

#### CAD CROSS SECTIONS

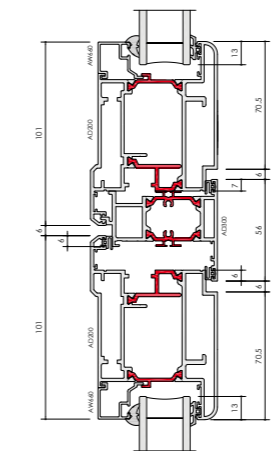
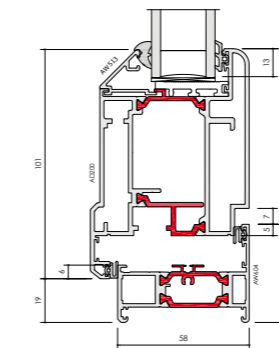
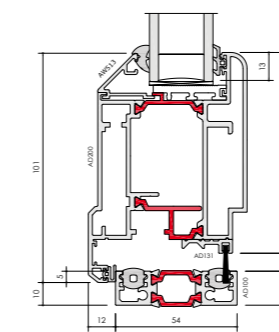

#### 58BD CONFIGURATIONS

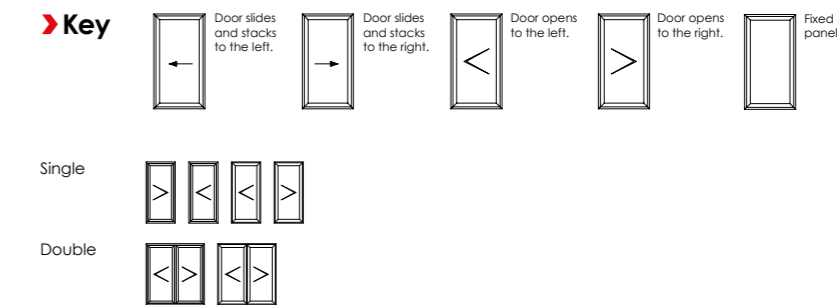

\* U-value (Double Glazing) - Single Doors are calculated using EN ISO 10077 - Part 2, 1000mm x 2180mm Single Door with Ug: 1.0 W/m²K using AW604 outerframe and AD200/AD201 vent. Double Doors are calculated using EN ISO 10077 - Part 2, 2000mm x 2180mm Single Door with Ug: 1.0 W/m²K using AW604 outerframe and AD200/AD201 vent.

† U-value (Triple Glazing) - Single Doors are calculated using EN ISO 10077 - Part 2, 1000mm x 2180mm Single Door with Ug: 0.7 W/m²K using AW604 outerframe and AD200/AD201 vent. Double Doors are calculated using EN ISO 10077 - Part 2, 2000mm x 2180mm Single Door with Ug: 0.7 W/m²K using AW604 outerframe and AD200/AD201 vent.



# GT55 TB Commercial Entrance

The Optio GT55 thermally broken aluminium commercial door system provides the most comprehensive PAS24 security for single, double door and fixed panel.



## SBD CONFIGURATIONS

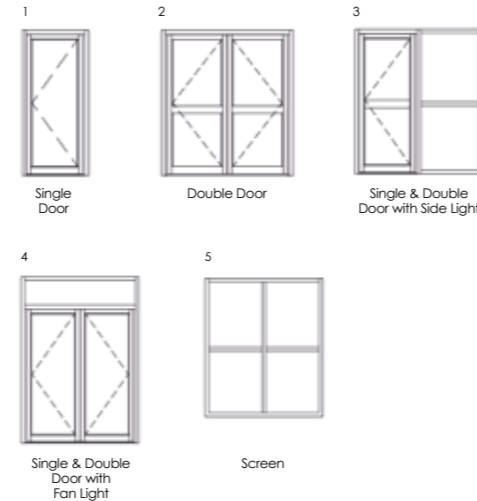

Options	GT55 TB	GT55 TB Screening	GT55 NI	GT55 NI Screening
Double acting central pivot door	✓	-	✓	-
<b>Finishes</b>				
Single colour	✓	✓	✓	✓
Dual colour	✓	✓	-	-
Textured	✓	✓	✓	✓
Anodised	✓	✓	✓	✓

## DESIGN FEATURES AND OPTIONS

- The most comprehensive PAS24 and SBD certified system on the market today – panic, mechanical and electro mechanical locking
- Accepts 24mm – 31mm double or triple glazing
- Max door leaf (double) 2000mm x 2180mm
- Max panel weight 110kg
- Double acting central pivot door, open in and out options

## PAS 24 SECURITY RATED LOCK

AluK Part Ref	Relevant Configurations	SINGLE DOOR				DOUBLE DOOR			
		Min (w)	Min (h)	Max (w)	Max (h)	Min (w)	Min (h)	Max (w)	Max (h)
XA680 - Trimec V Lock	1,2,3,4,5	500	-	1200	2400	500	-	1200	2400
XA835-838 - Dorma 9800 Panic	1,2,3,4,5	500	-	1200	2400	500	-	1200	2400
XA844-845 - Dorma 9800 Panic ES	1,2,3,4,5	500	-	1200	2400	500	-	1200	2400
XA885/886 - Sentinel M Panic	1,3,5	500	1882*	1200	2400	Not available for Double Door			
XA887 - Sentinel M Multi Point Lock	1,2,3,4,5	500	1882*	1000	2400	500	1882*	1000	2400

NB: \*Based on 1050mm Spindle height. Lock can be cropped (for shorter heights) if necessary. Contact AluK Technical to discuss.

## SPECIFICATIONS

Performance and accreditation	GT55 TB		GT55 TB Screening	GT55 NI		GT55 NI Screening
	Single	Double		Single	Double	
Air permeability (Pa) <sup>1</sup>	Class 0 (0 Pa)	Class 0 (0 Pa)	Class 4 (600 Pa)	Class 0 (0 Pa)	Class 0 (0 Pa)	Class 4 (600 Pa)
Water tightness (Pa) <sup>1</sup>	Class 1A (0 Pa)	Class 1A (0 Pa)	Class E1200 (1200 Pa)	Class 1A (0 Pa)	Class 1A (0 Pa)	Class 8A (450 Pa)
Wind resistance (Pa) <sup>1</sup>	Class 0 (0 Pa)	Class 0 (0 Pa)	Class B4 (1600 Pa)	Class 0 (0 Pa)	Class 0 (0 Pa)	Class 5 (2000 Pa)
Security	Q-mark	Q-mark	Q-mark	Q-mark	Q-mark	-
U value (double glazing) (Ug: 1.0 W/m <sup>2</sup> K) <sup>2,3,4</sup>	1.9 W/m <sup>2</sup> K	1.82 W/m <sup>2</sup> K	1.33 W/m <sup>2</sup> K	3.6 W/m <sup>2</sup> K	3.05 W/m <sup>2</sup> K	2.03 W/m <sup>2</sup> K
U value (triple glazing) (Ug: 0.7 W/m <sup>2</sup> K) <sup>2,3,4</sup>	1.72 W/m <sup>2</sup> K	1.62 W/m <sup>2</sup> K	1.07 W/m <sup>2</sup> K	3.42 W/m <sup>2</sup> K	2.86 W/m <sup>2</sup> K	1.77 W/m <sup>2</sup> K
3rd party certification	Q-mark	Q-mark	Q-mark	Q-mark	Q-mark	-
Durability EN 1191 category (cycles)	50,000	50,000	-	50,000	50,000	-
<b>System depth</b>						
Units (mm)	110 mm	110 mm	110 mm	110 mm	110 mm	110 mm
<b>Design features</b>						
Thermally broken	✓	✓	✓	-	-	-
Low threshold	✓	✓	-	✓	✓	-
Anti-finger trap	✓	✓	-	✓	✓	-
Sightlines	145 mm	176 mm	55 mm	144 mm	176 mm	55 mm
Feature design - angular contours	✓	✓	✓	✓	✓	✓
Mid-rail and lay bar	✓	✓	✓	✓	✓	✓
Panel door	✓	✓	-	✓	✓	-
<b>Hardware</b>						
Multi point locking	✓	✓	-	-	-	-
Single point locking	✓	✓	-	✓	✓	-
Concealed hinges	✓	✓	-	✓	✓	-
Barrel hinges	-	-	-	✓	✓	-
Electro mechanical locking	✓	✓	-	✓	✓	-
Panic exit devices (EN 1125)	✓	✓	-	✓	✓	-
<b>Maximum sizes &amp; weights</b>						
Maximum door leaf size (mm)	1000 x 2180	2000 x 2180	2000 x 2180	1000 x 2180	2000 x 2180	2000 x 2180
Maximum door leaf weight <sup>5,6</sup>	110 Kg	110 Kg	-	80 Kg	80 Kg	-
Maximum glazing thickness (single glazing) (mm)	npd	npd	6 - 12	6 - 12	6 - 12	6 - 12
Maximum glazing thickness (double glazing) (mm)	24 - 40	24 - 40	24 - 28	24 - 28	24 - 28	24 - 28
<b>Applications</b>						
New build	✓	✓	✓	✓	✓	✓
Refurbishment	✓	✓	✓	✓	✓	✓
Heavy commercial	✓	✓	✓	✓	✓	✓

U-values based on CEN size door (1000mm x 2180mm) using 1.0 W/m<sup>2</sup>K double glazing with warm edge Swisspacer V bar. All weather test data taken from BS EN 6375-1 (Part of PAS 23) based upon the highest performing door configuration. Sound insulation values are Rw reduction values and are based on tests using acoustic glazing. Please visit aluk.co.uk to download all BIM components and CAD files.

- 1 AWW wind results for GT55NI Screening based upon internal test results only.
- 2 U-value calculation in accordance EN 10077-2, single door size 1000mm x 2180mm.
- 3 U-value calculation in accordance EN 10077-2, double door size 2000mm x 2180mm.
- 4 U-value calculation in accordance EN 10077-2, screen size 2000mm x 2180mm.
- 5 GT55 TB max weight based upon the Dorma RTS87 door closer.
- 6 GT55 NI max weight based upon the Adams Rite ARC51N door closer.





Optio

# BSC94 Lift & Slide

For those looking for effortless operation, look no further than our premium lift and slide door. Its vital statistics are impossible to ignore.

Thermal U-Values of 1.5W/m<sup>2</sup>K (triple glazed). Panel weights of up to 400Kg. Sightlines as little as 45mm.

The list goes on. As do the benefits, including multiple configurations and a wide choice of colour finishes.



## DESIGN FEATURES

- Accepts 20mm – 31mm double glazing
- Max 400kg panel weight (double bogey)

## OPTIONS

- Available as Inline Sliding
- Slimmer sightline of 45mm available
- Multiple sliding configurations
- Mono or Dual rail options
- Available in single and dual colour  
Anodised finishes also available
- Range of hardware and security features

## SPECIFICATIONS

Performance and accreditation	BSC94
U-value (double glazing)* (Ug = 1.0W/m <sup>2</sup> K) (mono rail)	1.6 W/m <sup>2</sup> K
U-value (triple glazing)* (Ug = 0.7W/m <sup>2</sup> K) (mono rail)	1.4 W/m <sup>2</sup> K
U-value (double glazing)* (Ug = 1.0W/m <sup>2</sup> K) (dual rail)	1.7 W/m <sup>2</sup> K
U-value (triple glazing)* (Ug = 0.7W/m <sup>2</sup> K) (dual rail)	1.5 W/m <sup>2</sup> K
Green guide rating	C rated
Acoustic performance (dB)	npd
Air tightness (Pa)**	Class 4 (600 Pa)
Water tightness (Pa)**	Class 7A (300 Pa)
Wind load (Pa)**	C4 (1600 Pa)
Configuration & frame	
Opening	Lift & slide
Mono rail (105mm)	✓
Dual rail (94mm)	✓
Size limits	
Max vent weight***	400kg
Max frame height****	3000mm
System features	
Dual colour option	✓
Multi-point locking	✓
Glazing options	Internal
Glazing thickness	20mm – 31mm
Sightlines	100mm

Performance and accreditation	BSC94SLIM
U-value (double glazing)* (Ug = 1.0W/m <sup>2</sup> K) (mono rail)	x
U-value (triple glazing)* (Ug = 0.7W/m <sup>2</sup> K) (mono rail)	x
U-value (double glazing)* (Ug = 1.0W/m <sup>2</sup> K) (dual rail)	1.7 W/m <sup>2</sup> K
U-value (triple glazing)* (Ug = 0.7W/m <sup>2</sup> K) (dual rail)	1.5 W/m <sup>2</sup> K
Green guide rating	C rated
Acoustic performance (dB)	npd
Air tightness (Pa)**	Class 4 (600 Pa)
Water tightness (Pa)**	Class 7A (300 Pa)
Wind load (Pa)**	C4 (1600 Pa)
Configuration & frame	
Opening	Lift & slide
Mono rail (105mm)	x
Dual rail (94mm)	✓
Size limits	
Max vent weight***	400kg
Max frame height****	3000mm
System features	
Dual colour option	✓
Multi-point locking	✓
Glazing options	Internal
Glazing thickness	20mm – 31mm
Sightlines	45mm

## CAD CROSS SECTIONS

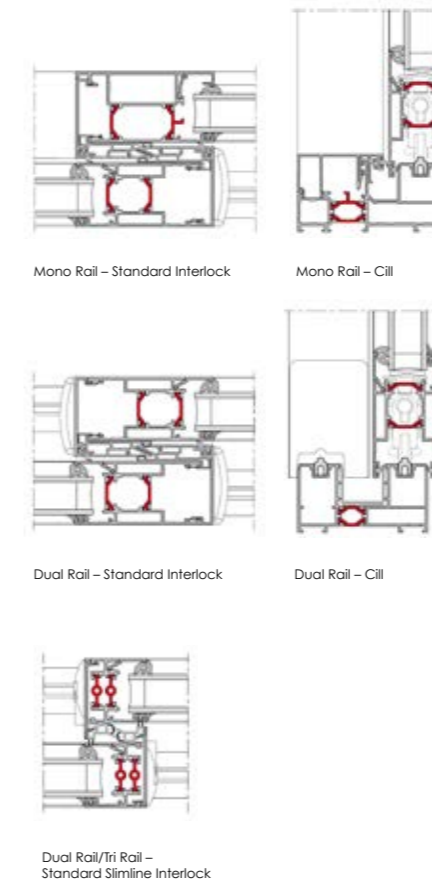

## BSC94 (LIFT & SLIDE) CONFIGURATIONS

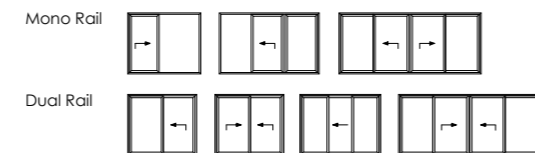
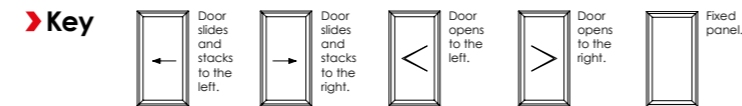

\*U-values based on CEN size door (2000mm x 2180mm).  
 \*\*All weather test data taken from BS EN 6375-1 based upon highest performing door configuration.  
 \*\*\*Based on using a Tandem bogie kit.  
 \*\*\*\*Dependent on wind load and lock variation.  
 Note: npd = No performance declared  
 Please visit [www.aluk.co.uk](http://www.aluk.co.uk) to download all BIM components and CAD files.





Optio

# BSC94 In-line Sliding

Combining high performance with stunning design, our sliding aluminium door systems provide a versatile solution for any architectural project.

Manufactured to the highest UK standards, this multi-configuration inline system offers outstanding thermal performance and a wide range of customisable options.



## DESIGN FEATURES

- › Accepts 20mm – 31mm double glazing
- › Max 400kg panel weight
- › Certified PAS 24
- › Anti bi-metal polyamide strip to allow for varying expansion rates

## OPTIONS

- › Available as Lift & Slide
- › Slimmer sightline of 45mm available
- › Multiple sliding configurations
- › Mono, Dual or Tri rail options
- › Available in single and dual colour  
Anodised finishes also available
- › Range of hardware and security features

## SPECIFICATIONS

Performance and accreditation	BSC94
U-value (double glazing)* (Ug = 1.0W/m²K) (mono rail)	1.7 W/m²K
U-value (triple glazing)* (Ug = 0.7W/m²K) (mono rail)	1.5 W/m²K
U-value (double glazing)* (Ug = 1.0W/m²K) (dual Rail)	1.9 W/m²K
U-value (triple glazing)* (Ug = 0.7W/m²K) (dual Rail)	1.7 W/m²K
Green guide rating	C rated
Acoustic performance (dB)	Rw (C;Ctr) 36 (-1;-3) dB**
Air tightness (Pa)***	Class 4 (600 Pa)
Water tightness (Pa)***	Class 7A (300 Pa)
Wind load (Pa)***	C4 (1600 Pa)
Security	PAS 24
Configuration & frame	
Opening	In-line sliding
Mono rail (105mm)	✓
Dual rail (94mm)	✓
Tri rail (155mm)	✓
Size limits	
Max vent weight****	400kg
Max frame height†	3000mm
Max frame height with security features	2600mm
System features	
Dual colour option	✓
Multi-point locking	✓
Glazing options	Internal
Glazing thickness	20mm - 31mm
Sightlines	85mm

## BSC94 (IN-LINE) CONFIGURATIONS

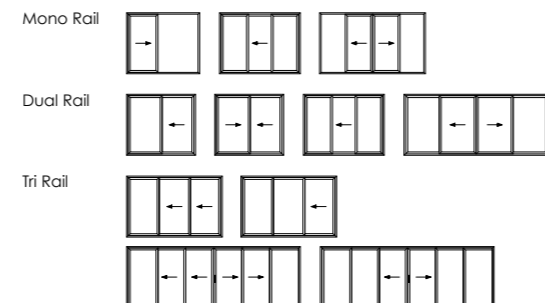
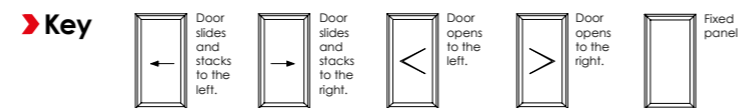

## CAD CROSS SECTIONS

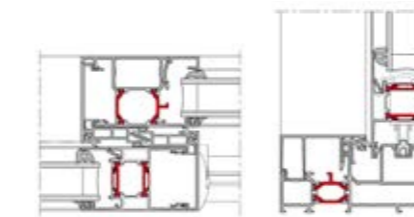

Mono Rail – Interlock

Mono Rail – Cill

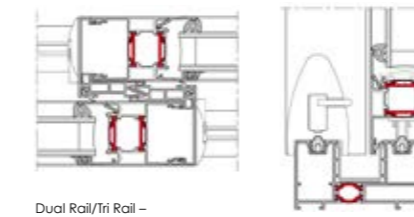

Dual Rail/Tri Rail – Standard Interlock

Dual Rail – Cill

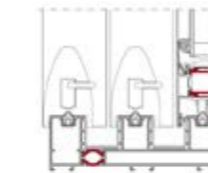

Tri Rail – Cill

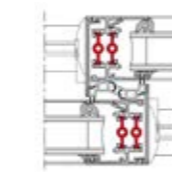

Dual Rail/Tri Rail – Standard Slimline Interlock

\*U-values based on CEN size door (2000mm x 2180mm).  
 \*\*Sound insulation values are Rw reduction values and are based on tests using acoustic glazing.  
 \*\*\*All weather test data taken from BS EN 6375-1 based upon highest performing door configuration.  
 \*\*\*\*Based on using double rollers.  
 †Dependent on wind load and lock variation.  
 Note: npd = No performance declared  
 Please visit [www.aluk.co.uk](http://www.aluk.co.uk) to download all BIM components and CAD files.





Luminia

# F82 Bi-fold

A contemporary, stylish bi-folding door. With thinner sightlines and interlock of 122mm that provide larger glazing panels without compromising on performance.

It also offers HD compact slim stainless steel rollers as standard allowing for a smoother movement when opening and closing. And with the re-design of the flush pop-out handle form and function perfectly work in harmony.



#### DESIGN FEATURES

- Re-designed flush pop-out handle
- Unique traffic door
- HD compact rollers as standard
- 4 stainless slim steel rollers
- Both frame and cill sightlines of 97mm
- All configurations available open in and open out

#### OPTIONS

- Chamfered and square bead options
- Glazing 28mm – 54mm
- Available in a range of opening configurations
- Available in a range of single or dual colour and anodised finishes
- All configurations available open in and open out
- Chamfered and square based options

#### SPECIFICATIONS

##### Performance and accreditation

	F82
*U-value (double glazing)	1.4 W/m²K
†U-value (triple glazing)	1.2 W/m²K
Air tightness (Pa) (standard threshold)	NPD (testing June 2017)
Water tightness (Pa) (standard threshold)	NPD (testing June 2017)
Wind load (Pa)	NPD (testing June 2017)
Security	NPD (testing June 2017)
3rd party certification	NPD (testing June 2017)
Secured by design	NPD (testing June 2017)

##### Configurations

Opening	Open in and open out
2-2-0	✓
3-3-0	✓
3-2-1	✓
4-4-0	✓
4-2-2	✓
4-3-1	✓
5-5-0	✓
5-3-2	✓
5-4-1	✓
6-6-0	✓
6-3-3	✓
6-4-2	✓
6-5-1	✓
7-7-0	✓
7-4-3	✓
7-5-2	✓
7-6-1	✓

##### Design features

Max vent weight	150 Kg
Sightline (Head)	97 mm
Sightline (Cill)	97 mm
Sightline (Jamb)	97 mm
Sightline (Meeting Stile)	122 mm
Maximum leaf height	2600 mm

##### System features

Frame depth	82 mm
Dual colour option	✓
Multi-point locking	✓
Glazing options	Internal bead
Glazing thickness	28 mm - 54 mm

##### F82 HI

1.3 W/m²K
1.1 W/m²K
NPD (testing June 2017)
NPD (testing June 2017)
NPD (testing June 2017)
NPD (testing June 2017)
NPD (testing June 2017)
NPD (testing June 2017)

##### Open in and open out

✓
✓
✓
✓
✓
✓
✓
✓
✓
✓
✓
✓
✓
✓
✓
✓
✓

##### 150 Kg

97 mm
97 mm
97 mm
122 mm
2600 mm

##### 82mm

✓
✓
Internal bead
28 mm - 54 mm

#### CAD CROSS SECTIONS

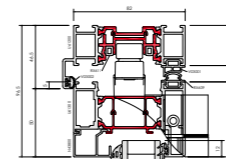

F82 Head

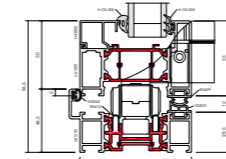

F82 Cill

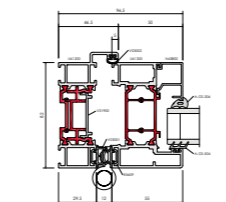

F82 Jamb

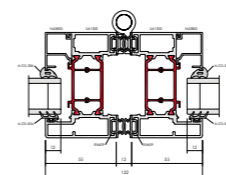

F82 Interlock

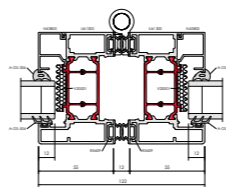

F82 HI Interlock

#### F82 CONFIGURATIONS

##### Key



##### Two Pane

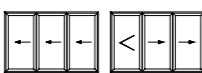
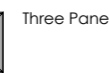

##### Four Pane

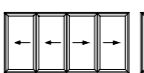

##### Five Pane



##### Six Pane

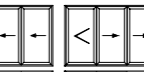
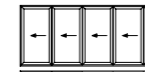

##### Seven Pane

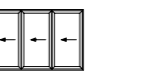
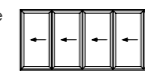

\* Folding Doors are calculated using EN ISO 10077 - Part 2, 3000mm x 2180mm, 3-3-0 Door with Ug: 1.0 W/m²K (double glazed) / 0.7 W/m²K (triple glazed) using P-06-100 outerframe and P-06-200 vent. Single and Double Door value is calculated using EN ISO 10077 - Part 2, 2000mm x 2180mm Double Door with Ug: 1.0 W/m²K (double glazed) / 0.7 W/m²K (triple glazed) using P-06-100 outerframe and P-06-200 vent.

† U-value (Double Glazing) - Folding Doors are calculated using EN ISO 10077 - Part 2, 3000mm x 2180mm, 3-3-0 Door with Ug: 1.0 W/m²K using P-06-100 outerframe and P-06-200 vent. Single and Double Door value is calculated using EN ISO 10077 - Part 2, 2000mm x 2180mm Double Door with Ug: 1.0 W/m²K using P-06-100 outerframe and P-06-200 vent.

‡ U-value (Triple Glazing) - Folding Doors are calculated using EN ISO 10077 - Part 2, 3000mm x 2180mm, 3-3-0 Door with Ug: 0.7 W/m²K using P-06-100 outerframe and P-06-200 vent. Single and Double Door value is calculated using EN ISO 10077 - Part 2, 2000mm x 2180mm Double Door with Ug: 0.7 W/m²K using P-06-100 outerframe and P-06-200 vent.





Optio

# BSF70 Bi-fold

An intelligent combination of form and function, our highly versatile and market-leading Bi-fold sliding door system gives you maximum control over the style and operation of the doors.

Multiple panels can be added to accommodate the design specifications of your building, with the option to open in or out as required.

The system also boasts a unique flush line pop-out handle that allows for square flush stacking panels when doors are fully open.



#### DESIGN FEATURES

- Certified under the Secured By Design scheme
- Tested to PAS 24
- Unique, pop-out handle that allows for maximum door opening and panels to stack square
- Four stainless steel rollers to ensure smooth and consistent operation

#### OPTIONS

- Chamfered and square bead options
- Glazing 28mm – 40mm
- Available in a range of opening configurations
- Available with heavy duty rollers; BSF70 HD
- Available in a range of single or dual colour and anodised finishes
- Low threshold 15mm step height
- All configurations available open in and open out
- Chamfered and square based options
- Shootbolts top and bottom of the interlock for enhanced security
- Dedicated bottom bogey guide for consistent operation and enhanced security
- Double track threshold allowing greater stability

#### SPECIFICATIONS

##### Performance and accreditation

	BSF70
*U-value (double glazing)	1.6 W/m <sup>2</sup> K
<sup>1</sup> U-value (triple glazing)	1.4 W/m <sup>2</sup> K
Air tightness (Pa) (standard threshold)	Class 4 (600 Pa)
Water tightness (Pa) (standard threshold)	Class 9A (600 Pa)
Wind load (Pa)	Class AE2400 (2400 Pa)
Security	PAS 24
3rd party certification	Q-mark
Secured by design	Yes

##### Configurations

Opening	Open in and open out
2-2-0	✓
3-3-0	✓
3-2-1	✓
4-4-0	✓
4-2-2	✓
4-3-1	✓
5-5-0	✓
5-3-2	✓
5-4-1	✓
6-6-0	✓
6-3-3	✓
6-4-2	✓
6-5-1	✓
7-7-0	✓
7-4-3	✓
7-5-2	✓
7-6-1	✓

##### Design features

Max vent weight	100 Kg
Sightline (Head)	110 mm
Sightline (Cill)	130 mm
Sightline (Jamb)	110 mm
Sightline (Meeting Stile)	140 mm
Maximum leaf height	2400 mm

##### System features

Frame depth	70mm
Dual colour option	✓
Multi-point locking	✓
Glazing options	Internal bead
Glazing thickness	24mm - 40mm

##### BSF70 HD

U-value	1.6 W/m <sup>2</sup> K
U-value	1.4 W/m <sup>2</sup> K
Air tightness	NPD
Water tightness	NPD
Wind load	NPD
Security	NPD
3rd party certification	NPD
Secured by design	NPD

##### Open in and open out

	✓
	✓
	✓
	✓
	✓
	✓
	✓
	✓
	✓
	✓
	✓
	✓
	✓
	✓
	✓
	✓
	✓
	✓
	✓

##### 130 Kg

110 mm
130 mm
110 mm
140 mm
2400 mm

##### 70mm

✓
✓
Internal bead
24mm - 40mm

#### CAD CROSS SECTIONS

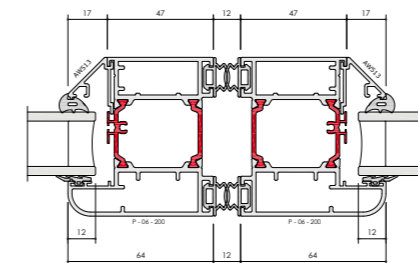
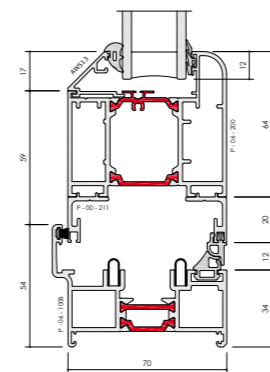

\* Folding Doors are calculated using EN ISO 10077 - Part 2, 3000mm x 2180mm, 3-3-0 Door with Ug: 1.0 W/m<sup>2</sup>K (double glazed) / 0.7 W/m<sup>2</sup>K (triple glazed) using P-06-100 outerframe and P-06-200 vent. Single and Double Door value is calculated using EN ISO 10077 - Part 2, 2000mm x 2180mm Double Door with Ug: 1.0 W/m<sup>2</sup>K (double glazed) / 0.7 W/m<sup>2</sup>K (triple glazed) using P-06-100 outerframe and P-06-200 vent.

• U-value (Double Glazing) - Folding Doors are calculated using EN ISO 10077 - Part 2, 3000mm x 2180mm, 3-3-0 Door with Ug: 1.0 W/m<sup>2</sup>K using P-06-100 outerframe and P-06-200 vent. Single and Double Door value is calculated using EN ISO 10077 - Part 2, 2000mm x 2180mm Double Door with Ug: 1.0 W/m<sup>2</sup>K using P-06-100 outerframe and P-06-200 vent.

<sup>1</sup>U-value (Triple Glazing) - Folding Doors are calculated using EN ISO 10077 - Part 2, 3000mm x 2180mm, 3-3-0 Door with Ug: 0.7 W/m<sup>2</sup>K using P-06-100 outerframe and P-06-200 vent. Single and Double Door value is calculated using EN ISO 10077 - Part 2, 2000mm x 2180mm Double Door with Ug: 0.7 W/m<sup>2</sup>K using P-06-100 outerframe and P-06-200 vent.

#### BSF70 CONFIGURATIONS

##### Key





## Hardware

# Finish in style

**When it comes to designing aluminium façade systems, we go to great lengths to ensure every part plays its part to perfection. No shortcuts are taken, no corners cut.**

We take the exact same approach when it comes to developing hardware. Every product is designed to not only complement our systems, but strikingly enhance them too.

Our tried, tested and trusted hardware range includes suited handles, locks, hinges, rollers, bogeys, seals and brushes. Each and every product has to pass our famously stringent tests, with most subjected to 50,000 operational cycles to emulate a lifetime of trouble-free operation. Then the real testing begins.

Our quality assurance team surveys every nut, every screw, every surface to ensure it's both scratch-free and up to scratch.

We also believe security should be a standard, not an aspiration. It's why almost every aluminium window and door system featuring our hardware is certified by the Secured by Design scheme.

Of course, added strength and security should never compromise style. And certainly never function. It's why our hardware products not only improve ease of operation for years to come, but deliver a timeless look and finish.





**T: 01291 639 739**  
**E: [info.uk@aluk.com](mailto:info.uk@aluk.com)**

Registered Office:  
AluK (GB) Ltd  
Newhouse Farm Ind Est  
Chepstow  
NP16 6UD

Registered Number:  
02881320

**[aluk.co.uk](http://aluk.co.uk)**

**Experts in Aluminium**

**ALUK<sup>®</sup>**