

### OUTER FRAMES

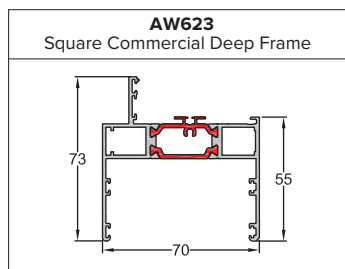

\*Please note these outer frames are not available for entrance doors. AW622 and AW623 can be used instead.

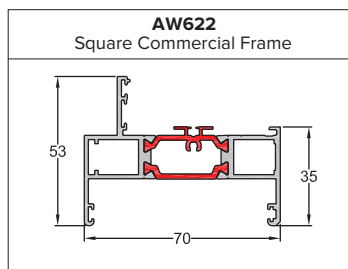
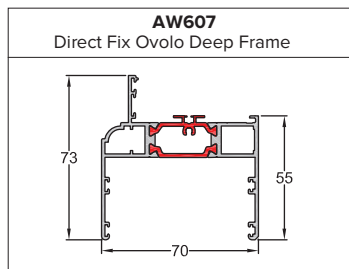
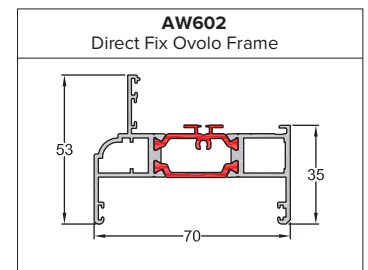
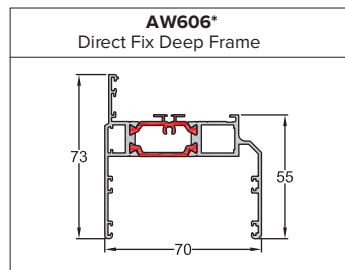
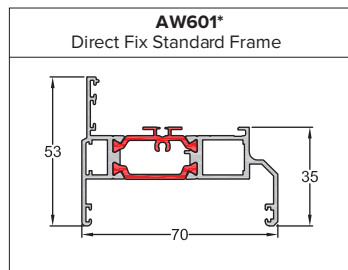
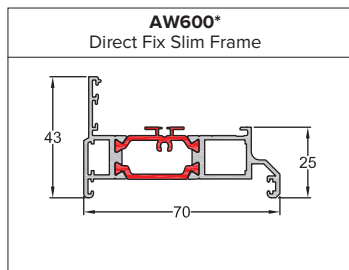
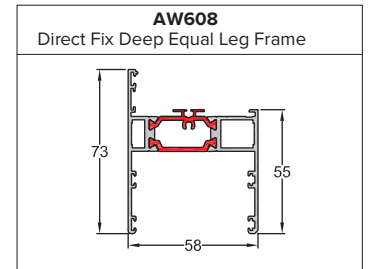
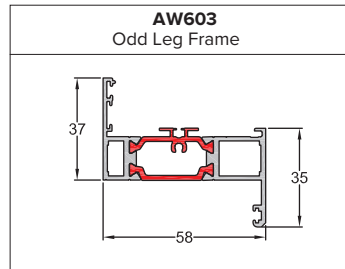
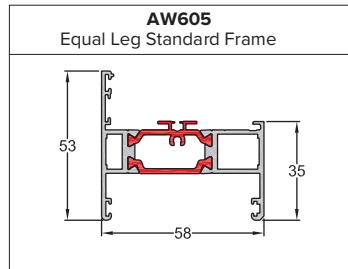
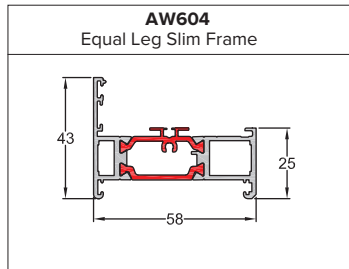
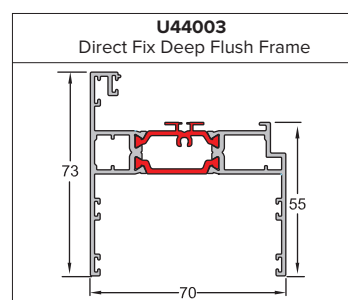
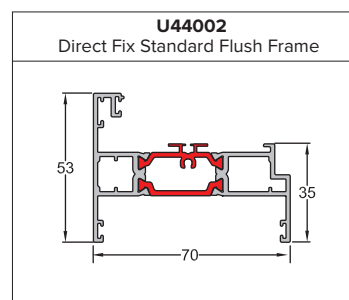
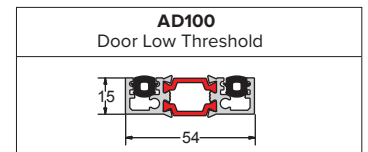

**Please note:** The default Outer Frame on our system is **AW605**. Our price list is based on this profile, alternative outer frames will incur an additional charge. Please ensure you specify the correct outer frame when submitting your enquiry/order.

### SASHES

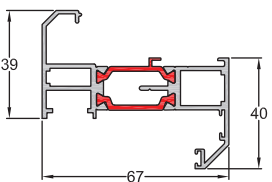
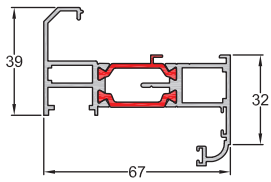
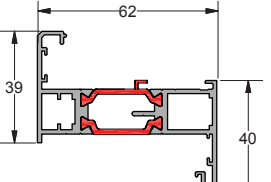
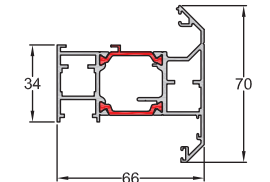
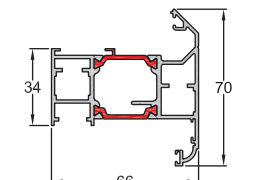
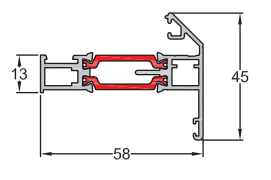
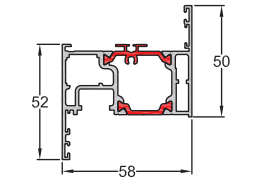
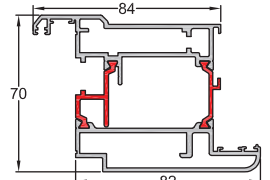
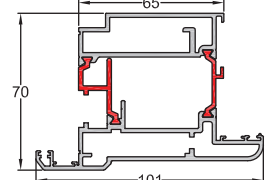
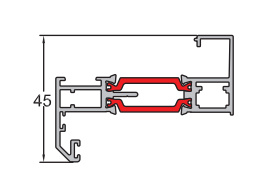
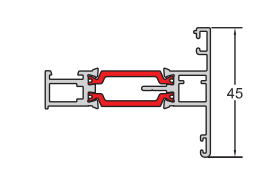
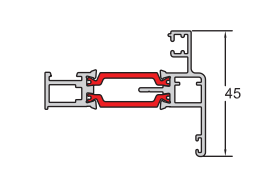
<p><b>AW611</b> Ext Glazed Euro Feature Vent</p> 	<p><b>AW613</b> Ext Glazed Euro Ovolo Vent</p> 	<p><b>AW624</b> Flat Espag Vent</p> 	<p><b>AW616</b> Int Glazed Euro Feature Vent</p> 
<p><b>AW618</b> Int Glazed Euro Ovolo Vent</p> 	<p><b>AW614</b> Int Glazed Flat Vent</p> 	<p><b>AW621</b> TBT Commercial Vent</p> 	<p><b>AD200</b> Open-In Feature Leaf</p> 
<p><b>AD201</b> Open-Out Feature Leaf</p> 	<p><b>AW690</b> Ext Glazed Slim Feature Vent</p> 	<p><b>AW685</b> Int Glazed Flat Line Vent</p> 	<p><b>AW686</b> Int Glazed Stepped Edge Vent</p> 

**Please note:** The default casement sash frame on our system is the slimline **AW611** for ext glazed windows and **AW614** for internally glazed windows. Our casement price list is based on this profile, alternative sashes will incur an additional charge. Please ensure you specify the correct outer frame when submitting your enquiry/order.

## TRANSOMS & MULLIONS

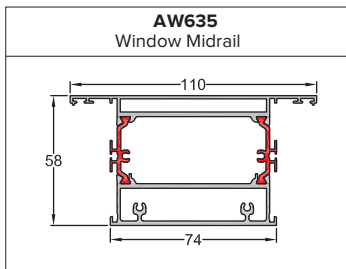
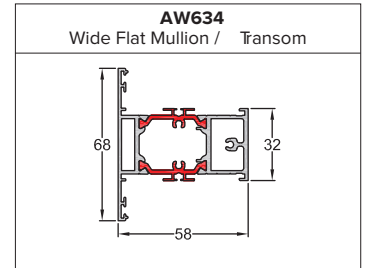
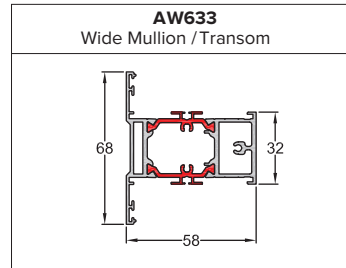
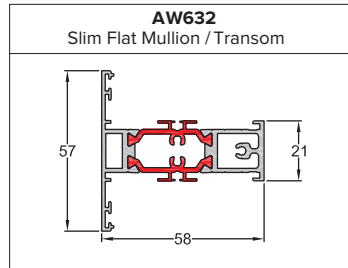
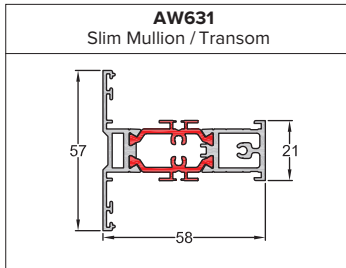

**Please note:** The default Transom/Mullion on our system is **AW632**. Our price list is based on this profile, alternative transom/mullions will incur an additional charge. Please ensure you specify the correct transom/mullion when submitting your enquiry/order.

## BEADS

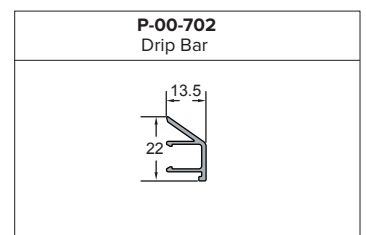
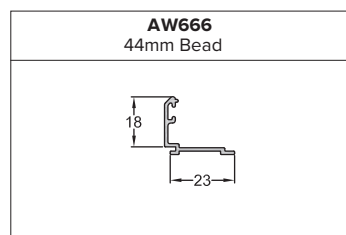
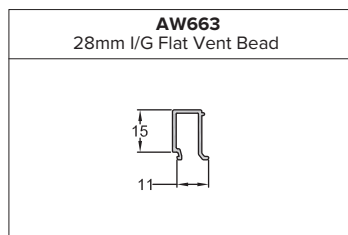
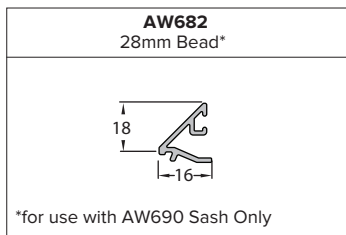
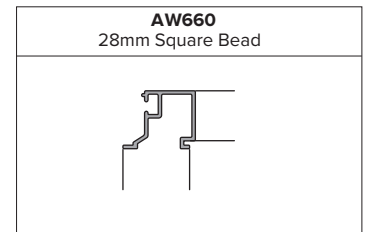
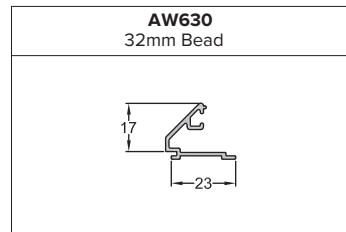
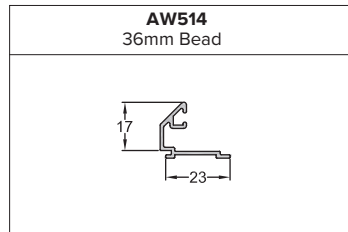
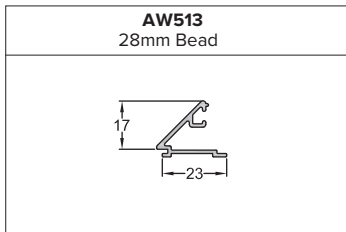

**Please note:** The default glazing bead on our system is **AW513**. Our price list is based on this bead. Please ensure you specify the correct glazing bead when submitting your enquiry/order.

### CILLS

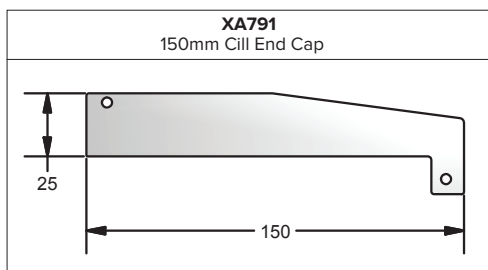
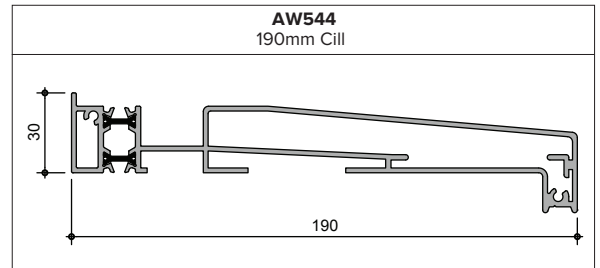
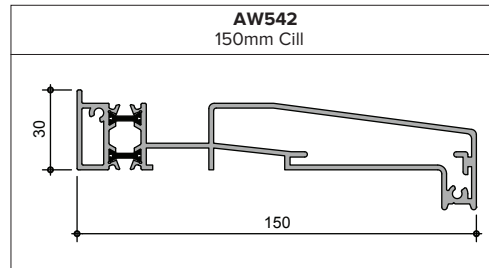
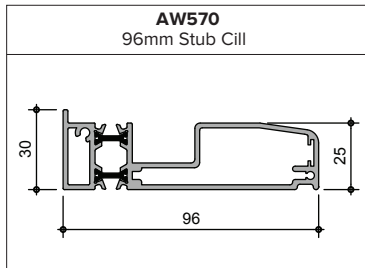

### COUPLER

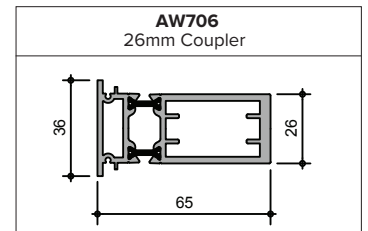
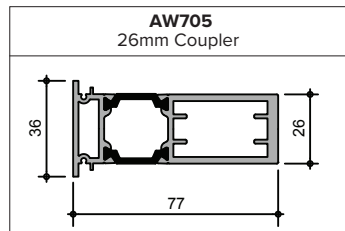
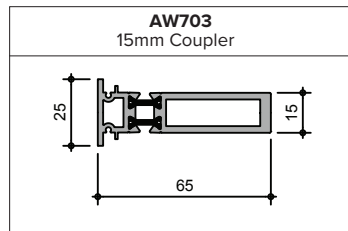
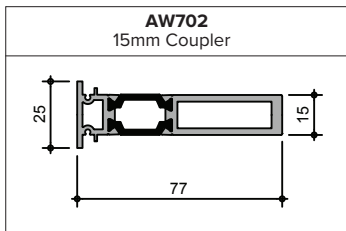

### FRAME EXTENDER

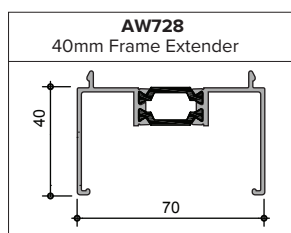
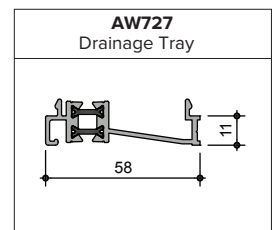
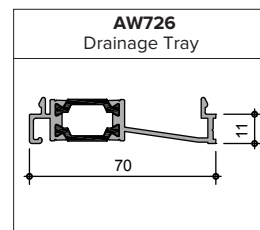
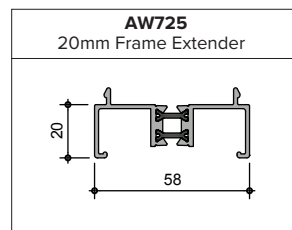
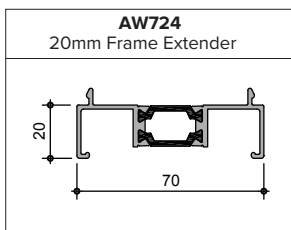

### BAY POLES

**AW712**  
Round Bay Pole

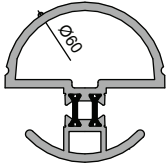

**AW715**  
100-120° Bay Pole (70mm)

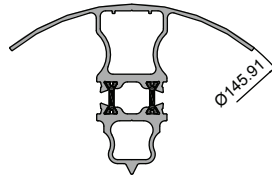

**AW716**  
120-140° Bay Pole (70mm)

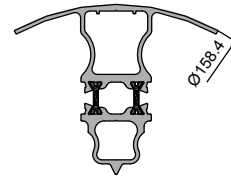

**AW717**  
140-160° Bay Pole (70mm)

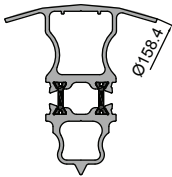

**AW718**  
160-180° Bay Pole (70mm)

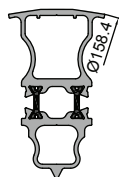

**AW720**  
90° Bay Pole

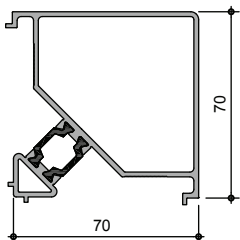

**AW721**  
90° Bay Pole

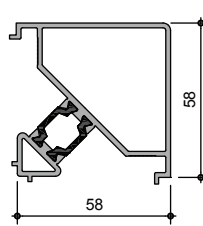

### INSTALLATION TRIMS

**AW645**  
12mm Quadrant



**AW646**  
25mm Architrave

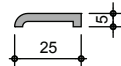

**AW648**  
70mm Architrave

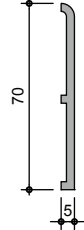

**AW647**  
35mm D Mould

