

OUTER FRAMES

<p>AW604 Equal Leg Slim Frame</p>	<p>AW605 Equal Leg Standard Frame</p>	<p>AW603 Odd Leg Frame</p>	<p>AW608 Direct Fix Deep Equal Leg Frame</p>
<p>AW600* Direct Fix Slim Frame</p>	<p>AW601* Direct Fix Standard Frame</p>	<p>AW606* Direct Fix Deep Frame</p>	<p>AW602 Direct Fix Ovolo Frame</p>
<p>AW607 Direct Fix Ovolo Deep Frame</p>	<p>AW622 Square Commercial Frame</p>	<p>AW623 Square Commercial Deep Frame</p>	<p>*Please note these outer frames are not available for entrance doors. AW622 and AW623 can be used instead.</p>
			<p>AD100 Door Low Threshold</p>

Please note: The default Outer Frame on our system is **AW605**. Our price list is based on this profile, alternative outer frames will incur an additional charge. Please ensure you specify the correct outer frame when submitting your enquiry/order.

SASHES

<p>AW611 Ext Glazed Euro Feature Vent</p>	<p>AW613 Ext Glazed Euro Ovolo Vent</p>	<p>AW624 Flat Espag Vent</p>	<p>AW616 Int Glazed Euro Feature Vent</p>
<p>AW618 Int Glazed Euro Ovolo Vent</p>	<p>AW614 Int Glazed Flat Vent</p>	<p>AW621 TBT Commercial Vent</p>	<p>AD200 Open-In Feature Leaf</p>
<p>AD201 Open-Out Feature Leaf</p>	<p>AW690 Ext Glazed Slim Feature Vent</p>	<p>AW685 Int Glazed Flat Line Vent</p>	<p>AW686 Int Glazed Stepped Edge Vent</p>

Please note: The default casement sash frame on our system is the slimline **AW611** for ext glazed windows and **AW614** for internally glazed windows. Our casement price list is based on this profile, alternative sashes will incur an additional charge. Please ensure you specify the correct outer frame when submitting your enquiry/order.

TRANSOMS & MULLIONS

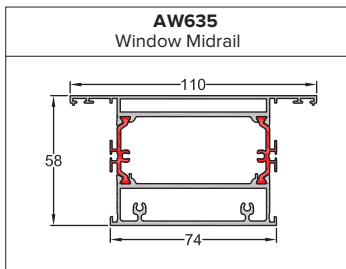
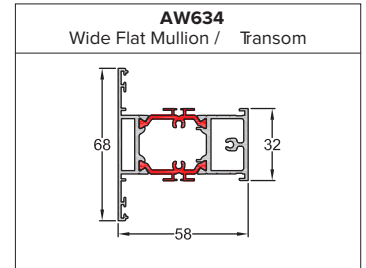
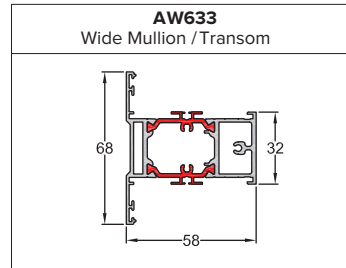
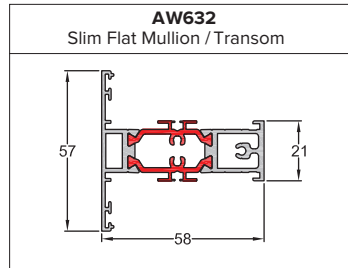
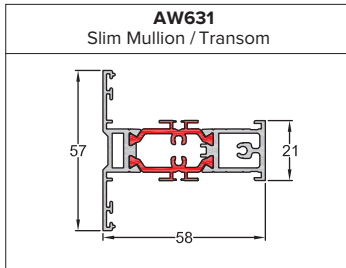

Please note: The default Transom/Mullion on our system is **AW632**. Our price list is based on this profile, alternative transom/mullions will incur an additional charge. Please ensure you specify the correct transom/mullion when submitting your enquiry/order.

BEADS

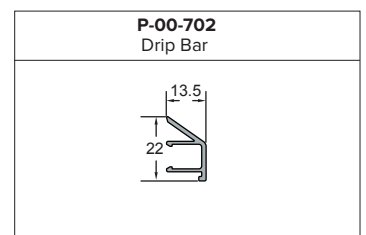
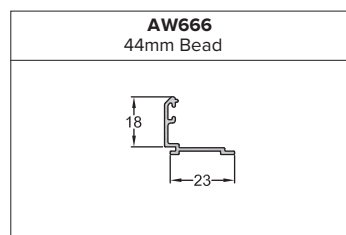
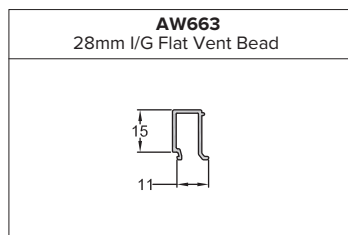
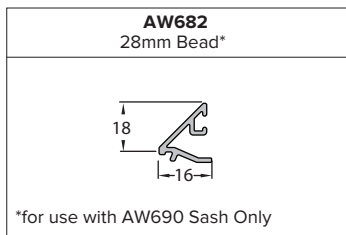
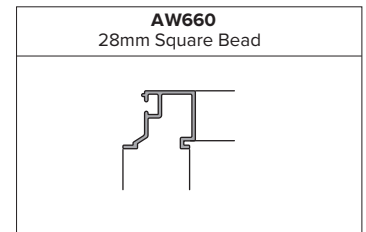
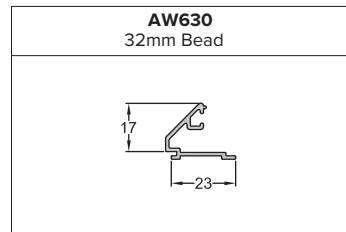
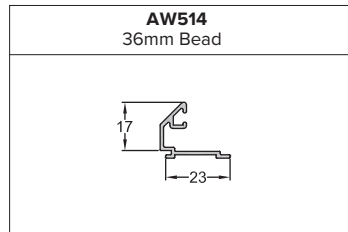
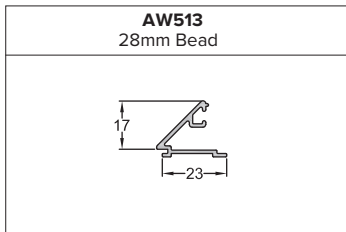

Please note: The default glazing bead on our system is **AW513**. Our price list is based on this bead. Please ensure you specify the correct glazing bead when submitting your enquiry/order.

CILLS

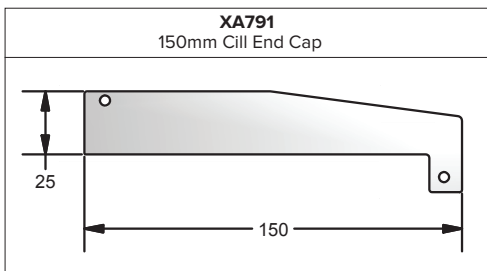
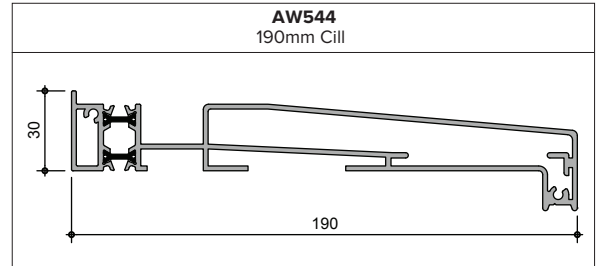
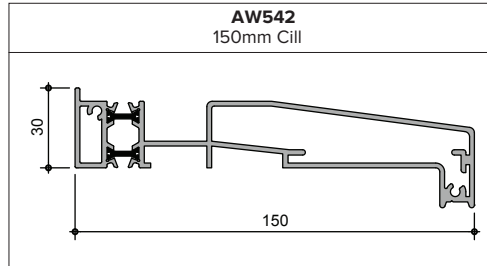
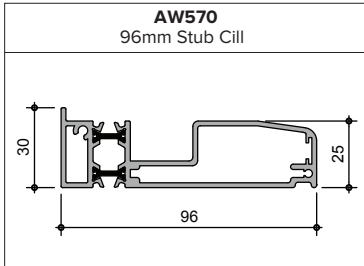

COUPLER

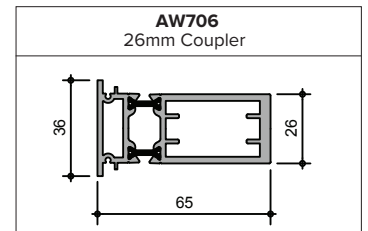
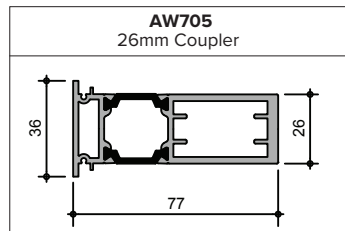
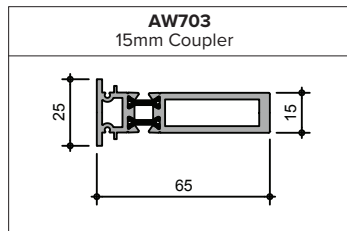
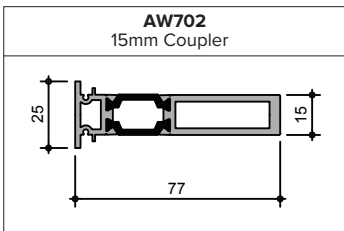

FRAME EXTENDER

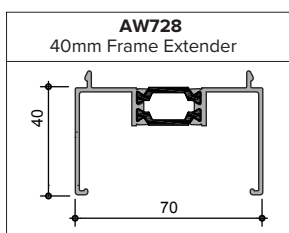
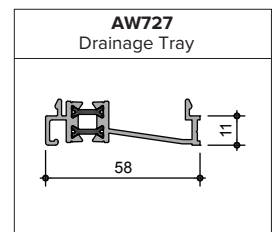
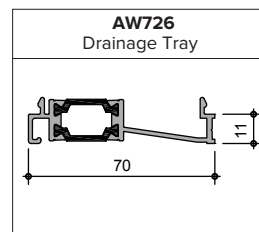
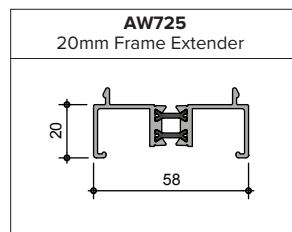
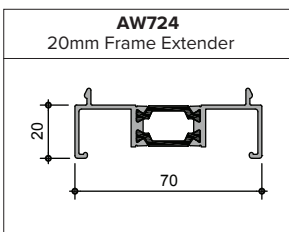

BAY POLES

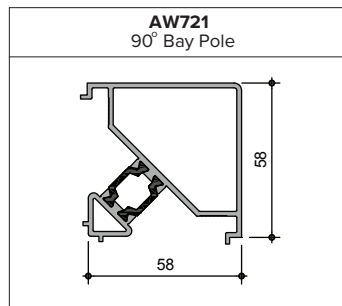
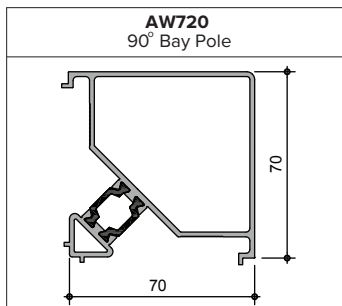
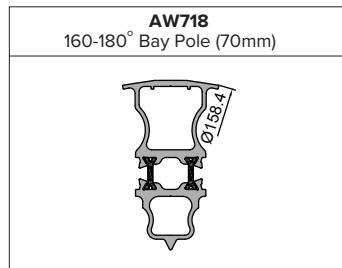
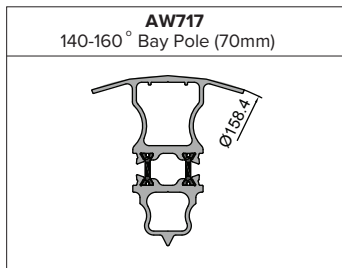
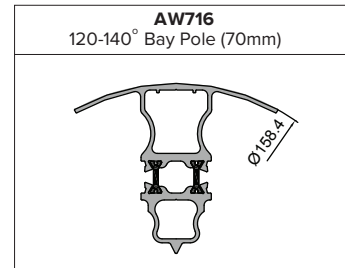
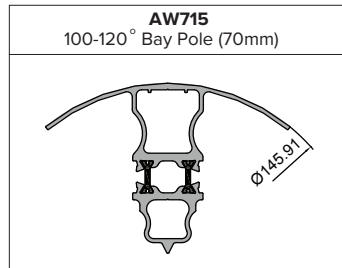
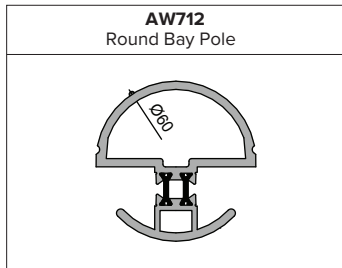

INSTALLATION TRIMS

